

# SCHEDA DI ATTIVAZIONE A 3 RELÉ COD: ACQ9081 (PER FUNZIONAMENTO QUADRICANALE DEI RADIO RICEVITORI RIB)

Questa scheda con i suoi 3 relé (KB1, KB2 e KB3), inserita nel connettore J2 delle centraline AQM, dà la possibilità per ogni suo relé di effettuare diversi tipi di azionamento. Ognuno dei relé ha contatti sia normalmente aperti NA che normalmente chiusi NC.

Per abilitare il funzionamento della scheda è necessario:

1° Se il radio ricevitore è del tipo RX-A ad auto-apprendimento, il suo ponticello P1 deve essere chiuso e deve essere effettuato un RESET del ricevitore (vedi manuale RX-A) - se del tipo RX433 c/dip non si deve toccare nessun ponticello.

2° Saldare le tre piazzole poste sul lato saldatore dei radio ricevitore RX433 e RX-A (nei 3 punti evidenziati con 4CH in fig 2 e 3) con tre gocce di stagno.

Per determinare il tipo di funzionamento dei relé della scheda è necessario:

1° Programmare il quadro AQM selezionando la FUNZIONE 7 e attivando le OPZIONI 1, 2, 7 ed 8 in base alle necessità (vedi tabella).

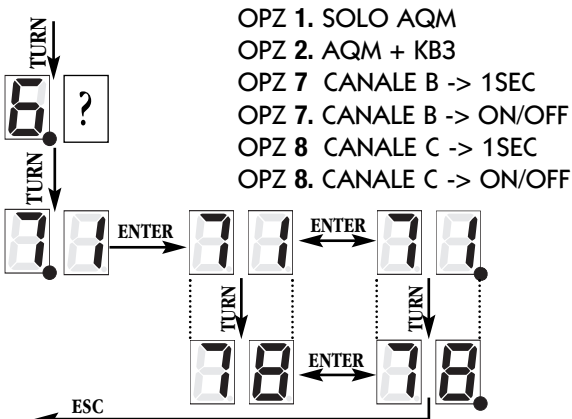

FUNZ 7	CANALE A	CANALE B RELÉ KB3	CANALE C RELÉ KB2	CANALE D RELÉ KB1
OPZ 1.+7+8	AQM	1SEC	1SEC	1SEC
OPZ 1.+7.+8	AQM	ON/OFF	1SEC	1SEC
OPZ 1.+7+8.	AQM	1SEC	ON/OFF	1SEC
OPZ 1.+7.+8.	AQM	ON/OFF	ON/OFF	1SEC
FUNZ 7	CANALE A + RELÉ KB3	CANALE B RELÉ KB2	CANALE C RELÉ KB1	CANALE D
OPZ 2.+7+8	AQM+KB3	1SEC	1SEC	-
OPZ 2.+7.+8	AQM+KB3	ON/OFF	1SEC	-
OPZ 2.+7+8.	AQM+KB3	1SEC	ON/OFF	-
OPZ 2.+7.+8.	AQM+KB3	ON/OFF	ON/OFF	-

**LEGENDA:**

**QUADRO**

- L'impulso del telecomando canale A è dedicato all'attivazione della centralina

**QUADRO + KB3**

- L'impulso del telecomando canale A oltre ad attivare la centralina attiva anche il relé KB3 il quale può alimentare un carico massimo di 40W (lampada di cortesia) come segue:

**FUNZ 1 OPZ 8.** - Il Relé KB3 si eccita per un tempo regolabile da 1 a 15 minuti (vedi manuale AQM).

**FUNZ 1 OPZ 9.** - Il Relé KB3 si eccita per 1 secondo (vedi manuale AQM).

**1SEC**

- Il relé interessato si attiva per 1 secondo (es. attivazione altre centrali)

**ON/OFF**

- Il relé interessato si attiva e si disattiva solo in seguito a dei successivi impulsi ricevuti dal telecomando (es. allarmi)

**CANALE**

- Esistono telecomandi con 1,2,3,4 tasti a cui corrispondono i canali A,AB,ABC ed ABCD. La pressione su di un tasto di un telecomando corrisponde al canale A o B o C o D di un radio ricevitore.

**FUNZ e OPZ**

- Sono termini corrispondenti a FUNZIONE ed OPZIONE e la loro gestione è indicata nel manuale AQM.

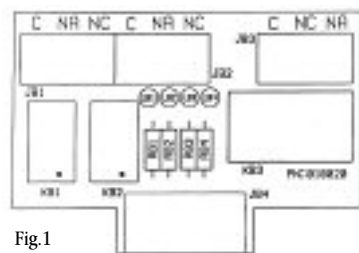

Fig.1

Fig.2 RX433 c/dip

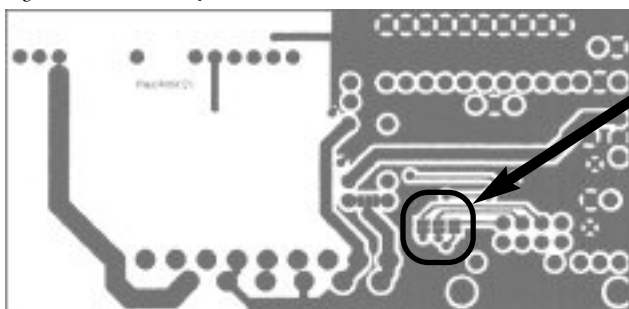
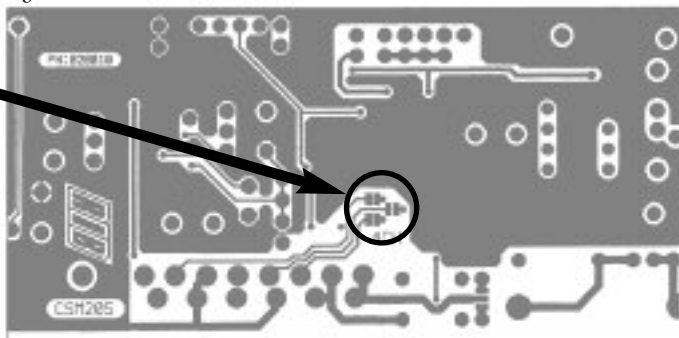

Fig.3 RX-A



4CH

Eseguire la scelta del tipo di funzionamento desiderato come segue:

- **Accensione di una lampada da 40W per un tempo selezionabile da minimo 1 minuto a max 15 minuti (lampada collegata a KB3):** Settare la FUNZIONE 1 OPZIONE 8 come descritto sul manuale AQM per il tempo desiderato, quindi eseguire il cablaggio come da figura 4.

- **Accensione di più lampade tramite relé per un tempo selezionabile da minimo 1**

**minuto a max 15 minuti:** Settare la FUNZIONE 1 OPZIONE 8 come descritto sul manuale AQM per il tempo desiderato, quindi eseguire il cablaggio come da figura 5.

- **Accensione di più lampade tramite relé temporizzato (1 secondo):** Settare la FUNZIONE 1 OPZIONE 9 come descritto sul manuale AQM per il tempo desiderato, quindi eseguire il cablaggio come da figura 6.

Nota: Le OPZIONI 8 e 9 non sono combinabili.

Fig.4

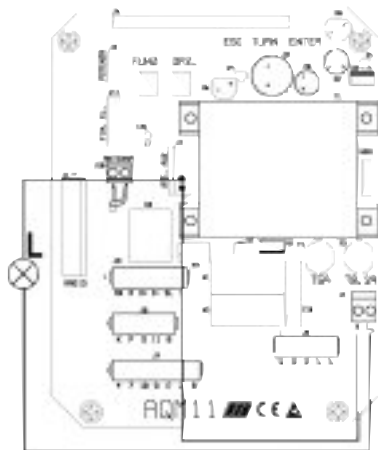

Fig.5

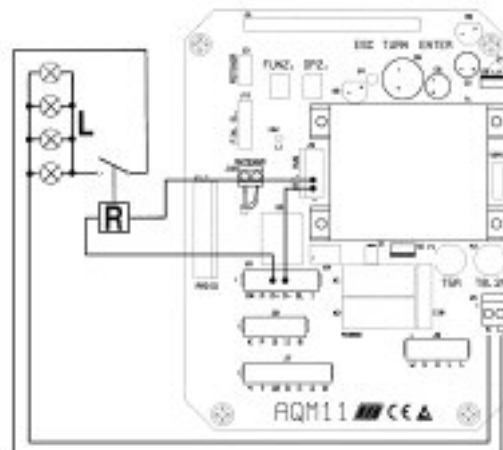
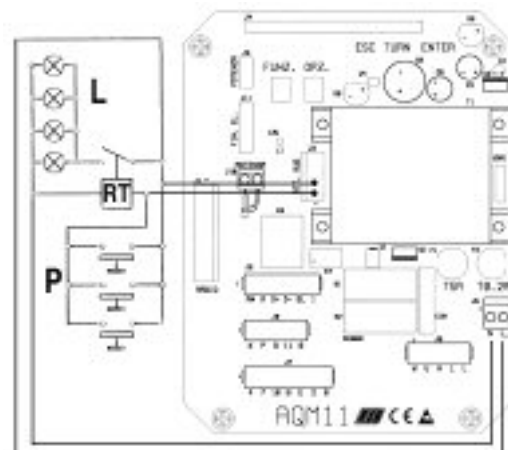

Fig.6



L = Lampada  
 L<sub>1</sub>N = 230Vac  
 R = Relé

RT = Relé temporizzato  
 P = Pulsante  
 D+D- = 12Vdc



**RIB**® 25014 CASTENEDOLO (BS)-ITALY  
 Via Matteotti, 162  
 Telefono ++39.030.2135811  
 Telefax ++39.030.21358279  
 e-mail: ribind@ribind.it

# THREE-RELAY CONTROL CARD, CODE NO.ACQ9081 (FOR FOUR CHANNEL OPERATION OF RIB RADIO RECEIVERS)

The card, equipped with three relays, is inserted in connector J2 of AQM control units and can be used for different purposes.

Each relay can be used with both NO and NC contacts.

To enable card operation proceed as follows:

1. If Radioreceiver is RX-A self learning type, its jumper P1 must be closed and you have to RESET the receiver (see Manual RX-A); if it is RX433 with dip type there is no jumper to touch.
2. Solder the three bump contacts on the soldering side of radio receivers RX433 nad RX-A (in the location marked 4CH in fig. 2 and 3) with three droplets of solder.

To enable the type of relay operation mode on the card it is necessary:

1. Programm AQM control board selecting Function 7 and selecting Options 1,2,7 and 8 as required (see table)

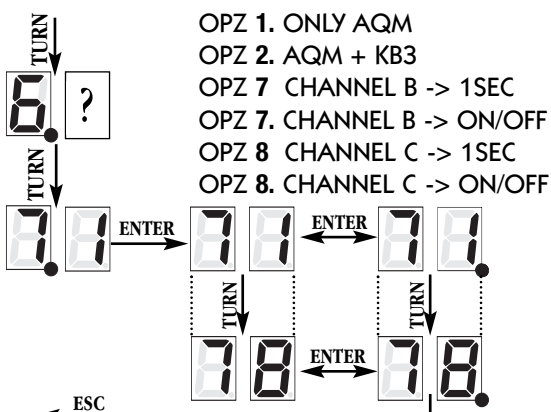

FUNZ 7	CHANNEL A	CHANNEL B RELAY KB3	CHANNEL C RELAY KB2	CHANNEL D RELAY KB1
OPZ 1.+7+8	AQM	1SEC	1SEC	1SEC
OPZ 1.+7.+8	AQM	ON/OFF	1SEC	1SEC
OPZ 1.+7.+8.	AQM	1SEC	ON/OFF	1SEC
OPZ 1.+7.+8.	AQM	ON/OFF	ON/OFF	1SEC
FUNZ 7	CHANNEL A + RELAY KB3	CHANNEL B RELAY KB2	CHANNEL C RELAY KB1	CHANNEL D
OPZ 2.+7+8	AQM+KB3	1SEC	1SEC	-
OPZ 2.+7.+8	AQM+KB3	ON/OFF	1SEC	-
OPZ 2.+7.+8.	AQM+KB3	1SEC	ON/OFF	-
OPZ 2.+7.+8.	AQM+KB3	ON/OFF	ON/OFF	-

- KEY:**
- PANEL - The remote control channel A pulse is used to activate the control unit
  - PANEL + KB3 - The remote control channel A pulse activates the control unit and also relay KB3 which can supply a maximum of 40W as follows:
    - FUNZ 1 OPZ8. - KB3 is energised for an adjustable interval between 1 and 15 minutes.
    - FUNZ 1 OPZ9. - KB3 is energised for 1 second.
  - 1SEC - The specific relay is energised for 1 second (e.g. activation of other control units)
  - ON/OFF - The specific relay is energised and de-energised only following pulses received via radio (e.g. alarms)
  - CHANNEL - There are transmitters with 1,2,3,4 buttons to which correspond the channels A,AB,ABC,ABCD. The pressure on a button of the transmitter correspond to channel A or B or C or D of the radioreceiver.
  - FUNZ and OPZ - These terms correspond to FUNCTION and OPTION and their management is explained in the manual AQM.

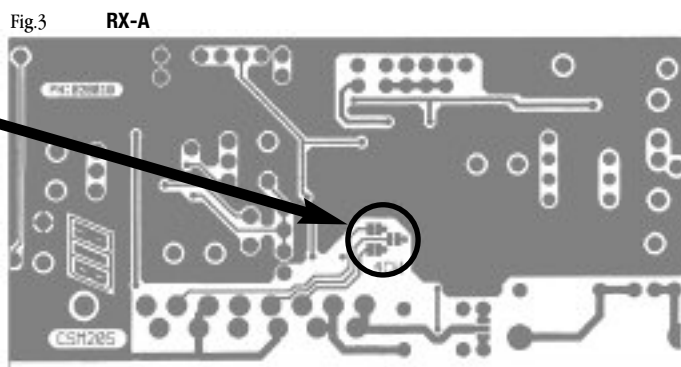
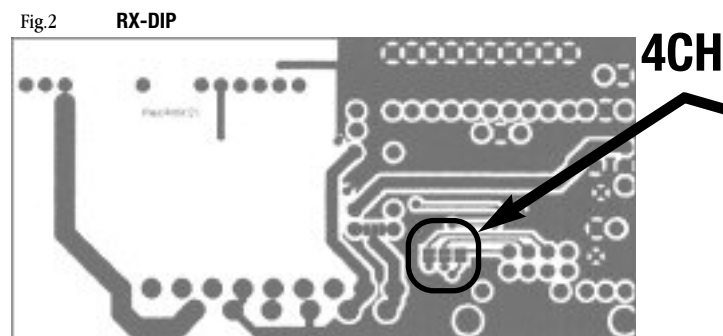
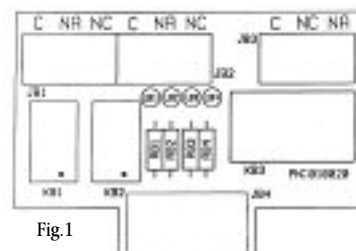

- The required operation mode can now be selected as follows:
- Activation of a 40W lamp for an adjustable interval between minimum 1 and maximum 15 minutes (connected to KB3): Set Function 1 Option 8 to the required time as described in the AQM manual, and wire as shown in figure 4.
  - Activation of multiple lamps by means of a relay for an interval adjustable between 1 and 15 minutes (max.): Set Function 1 Option 8 to the required time as described in

- the AQM manual, and wire as shown in figure 5.
- Activation of multiple lamps by means of timed relay (1 second)  
 Set Function 1 Option 9 to the required time as described in the AQM manual, and wire as shown in figure 6.  
 N.B. Options 8 and 9 cannot be combined.

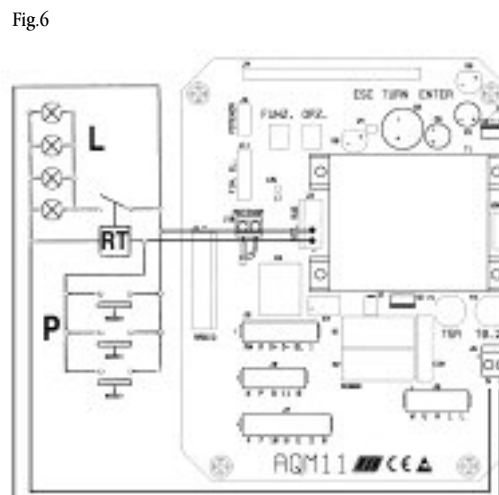
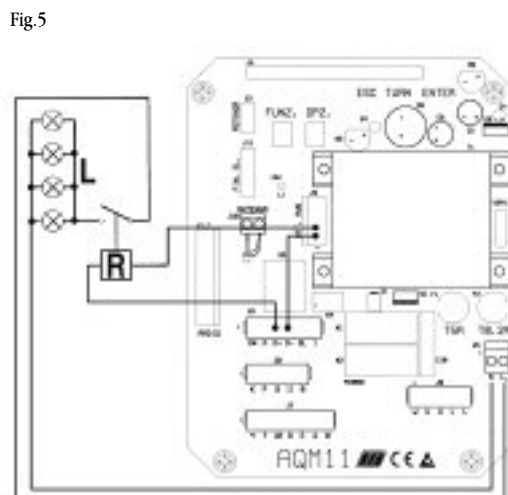
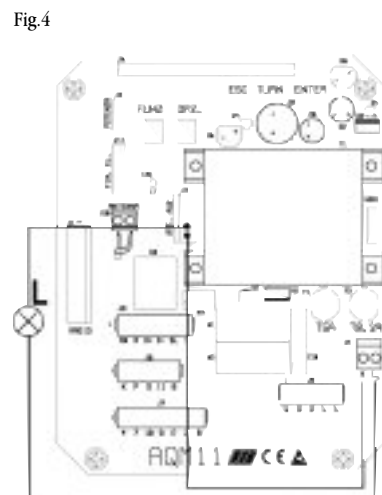

- L = Lamp
- L1N = 230 V ac
- R = Relay
- RT = Timed Relay
- P = Pushbutton
- D+D- = 12 V dc



# CARTE D'ACTIVATION À 3 RELAIS CODE : ACQ9081 (POUR FONCTIONNEMENT À QUATRE CANAUX DES RÉCEPTEURS RADIO RIB)

Cette carte avec ses 3 relais, embrochée sur le connecteur J2 des centrales AQM, permet différents types de fonctionnement pour chaque relais.

Il est possible d'utiliser, pour chacun de ces relais, des contacts aussi bien normalement ouverts NO que normalement fermés NF.

Pour habiliter le fonctionnement de la carte, il est nécessaire :

- 1° Si le récepteur radio est du type RX-A a apprentissage, le pont P1 doit être fermé, puis on doit effectuer un RESET sur le récepteur (voir manuel RX-A) - S'il est du type a dip switch RX-DIP maintenir le pont sur le canal A.
- 2° Effectuer une soudure sur chacun des trois "double points" cote soudures du récepteur (voir Fig. 2 et 3).

Pour déterminer le type de fonctionnement des relais il est nécessaire de :

- 1° Programmer le coffret AQM en sélectionnant le Fonction 7 et les Options 1,2,7 et 8 selon le fonctionnement désiré (voir tableau ci dessous).

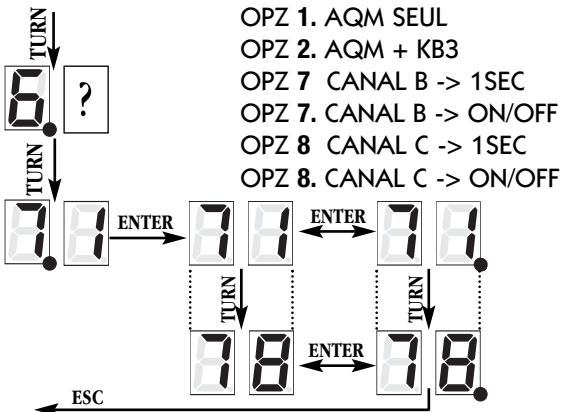

- OPZ 1. AQM SEUL
- OPZ 2. AQM + KB3
- OPZ 7. CANAL B -> 1SEC
- OPZ 7. CANAL B -> ON/OFF
- OPZ 8. CANAL C -> 1SEC
- OPZ 8. CANAL C -> ON/OFF

FUNZ 7	CANAL A	CANAL B RELAIS KB3	CANAL C RELAIS KB2	CANAL D RELAIS KB1
OPZ 1.+7+8	AQM	1SEC	1SEC	1SEC
OPZ 1.+7.+8	AQM	ON/OFF	1SEC	1SEC
OPZ 1.+7+8.	AQM	1SEC	ON/OFF	1SEC
OPZ 1.+7.+8.	AQM	ON/OFF	ON/OFF	1SEC
FUNZ 7	CANAL A + RELAIS KB3	CANAL B RELAIS KB2	CANAL C RELAIS KB1	CANAL D
OPZ 2.+7+8	AQM+KB3	1SEC	1SEC	-
OPZ 2.+7.+8	AQM+KB3	ON/OFF	1SEC	-
OPZ 2.+7+8.	AQM+KB3	1SEC	ON/OFF	-
OPZ 2.+7.+8.	AQM+KB3	ON/OFF	ON/OFF	-

**LEGENDE :**

- TABLEAU - L'impulsion de la télécommande canal A est dédiée à l'activation de la centrale
- TABLEAU + KB3 - L'impulsion de la télécommande canal A, outre qu'activer la centrale, active également le relais KB3 qui peut alimenter une charge maximale de 40W de la façon suivante :
  - FONCT 1 OPT8. - KB3 s'excite pendant un temps réglable entre 1 et 15 minutes.
  - FONCT 1 OPT9. - KB3 s'excite pendant 1 seconde.
- 1SEC - Le relais concerné s'active pendant 1 seconde (ex. activation autres centrales)
- ON/OFF - Le relais concerné s'active et se désactive uniquement à la suite des impulsions successives reçues par radio (ex. alarmes)
- CANAL - Il existe des émetteurs avec 1,2,3 ou 4 boutons qui correspondent aux canaux A,AB,ABC ou ABCD. Ces boutons correspondent au canal A ou B ou C ou D du récepteur.
- FUNZ et OPZ - Abbreviation des Fonction et Options Décrites dans le manuel AQM.

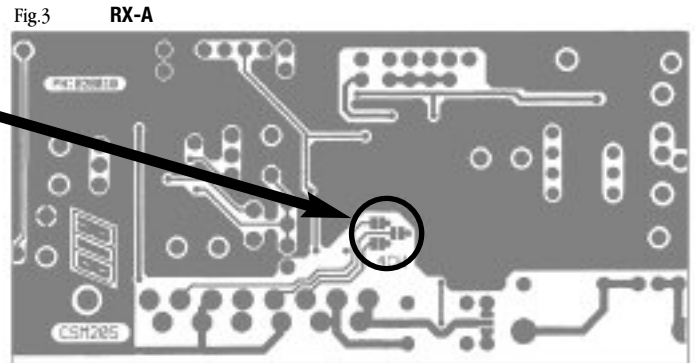
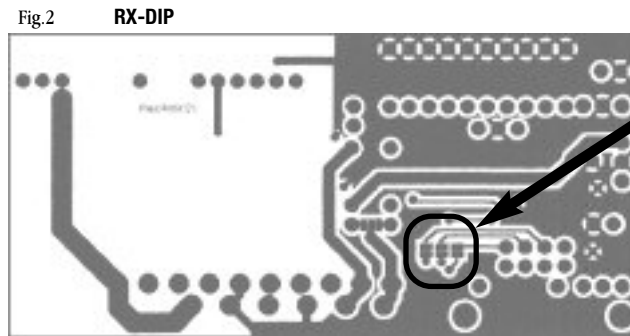
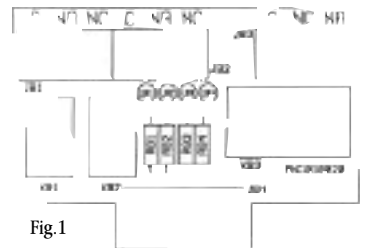

- A ce point, choisir le type de fonctionnement désiré de la façon suivante :
  - Allumage d'une lampe de 40W pendant un temps réglable entre un minimum de 1 minute et un maximum de 15 minutes (relié à KB3): Régler la FONCTION 1 OPTion 8 comme décrit dans le manuel AQM pendant le temps désiré, puis effectuer le câblage comme illustré à la figure 4.
  - Allumage de plusieurs lampes par relais pendant un temps réglable entre un minimum de 1 minute et un maximum de 15 minutes: Régler la FONCTION 1 OPTion 8

- comme décrit dans le manuel AQM pendant le temps désiré, puis effectuer le câblage comme illustré à la figure 5.
- Allumage de plusieurs lampes par relais temporisé (1 seconde): Régler la FONCTION 1 OPTion 9 comme décrit dans le manuel AQM pendant le temps désiré, puis effectuer le câblage comme illustré à la figure 6.

Remarque: Les OPTIONS 8 et 9 ne peuvent être sélectionnée en simultanée.

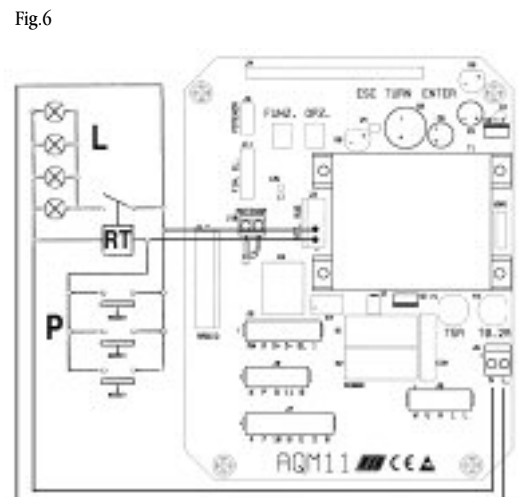
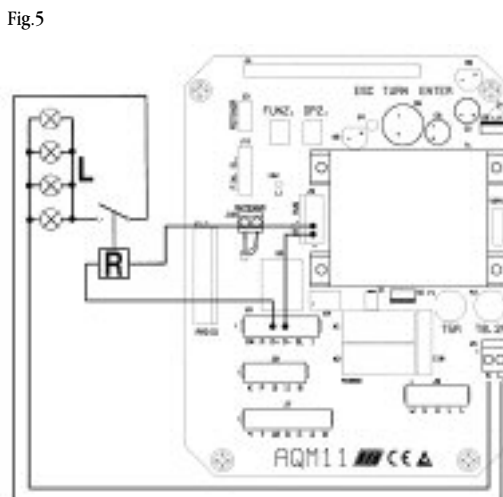
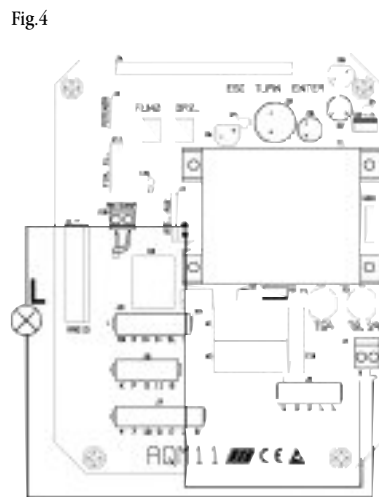

- L = Lampe
- L1N = 230Vca
- R = Relais
- RT = Relais temporisé
- P = Bouton
- D+D- = 12Vcc





# AKTIVIERUNGSEINSCHUB MIT 3 RELAIS, TEILENUMMER ACQ9081 (FÜR DEN VIERKANALIGEN BETRIEB DER RIB-FUNKEMPFÄNGER).

Dieser Einschub mit seinen 3 Relais (KB1,KB2 und KB3), der an den Stecker J2 der AQM-Geraete anzuschliessen ist, erlaubt an jeder Relais verschiedene Betreibungen auszuführen. Für jedes der vorhandenen Relais stehen sowohl Schließer- als auch Öffnerkontakte zur Verfügung.

Zur Inbetriebnahme des Einschubs ist folgendes erforderlich :

- 1) Ob der Funkempfänger Teach-in-Ausfuehrungen RX-A Typ ist, muss ihr Brueck geschlossen sein (sehen Handbuch RXA). Ob es RX433 mit dip ist, muss man kein Brueck beruehen.
- 2) Verloeten, mit drei Topfen Loetzinn, der drei Loestellen an der Loetseite der Funkempfaenger RX433 und RX-A (in dem in Abb.2 und 3 mit 4CH bezeichneten Punkt).

Um die Betriebsart der Relais der Platine zu bestimmen, ist es notwendig:

- 1) Den Steuerung AQM programmieren und die Funktion 7 und die benoetigten Option 1,2,7 und 8 aktivieren (sehen Tabelle)

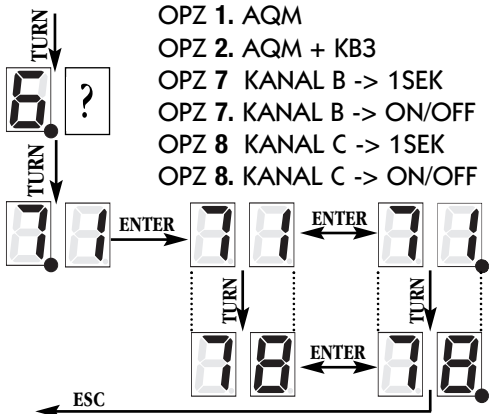

- OPZ 1. AQM
- OPZ 2. AQM + KB3
- OPZ 7 KANAL B -> 1SEK
- OPZ 7. KANAL B -> ON/OFF
- OPZ 8 KANAL C -> 1SEK
- OPZ 8. KANAL C -> ON/OFF

FUNZ 7	KANAL A	KANAL B RELAIS KB3	KANAL C RELAIS KB2	KANAL D RELAIS KB1
OPZ 1.+7+8	AQM	1SEK	1SEK	1SEK
OPZ 1.+7.+8	AQM	ON/OFF	1SEK	1SEK
OPZ 1.+7+8.	AQM	1SEK	ON/OFF	1SEK
OPZ 1.+7.+8.	AQM	ON/OFF	ON/OFF	1SEK
FUNZ 7	KANAL A + RELAIS KB3	KANAL B RELAIS KB2	KANAL C RELAISKB1	KANAL D
OPZ 2.+7+8	AQM+KB3	1SEK	1SEK	-
OPZ 2.+7.+8	AQM+KB3	ON/OFF	1SEK	-
OPZ 2.+7+8.	AQM+KB3	1SEK	ON/OFF	-
OPZ 2.+7.+8.	AQM+KB3	ON/OFF	ON/OFF	-

### LEGENDE :

- SCHALTAFEL** - Der Impuls des Kanals A der Fernsteuerung ist der Aktivierung des Zentralgeräts vorbehalten
- SCHALT. + KB3** - Der Impuls des Kanals A der Fernsteuerung aktiviert zusätzlich zum Zentralgerät auch das Relais KB3, das eine maximale Leistung von 40W ermöglicht, und zwar :  
**FUNZ 1 OPZ 8** KB3 zieht für eine zwischen 1 und 15 Minuten einstellbare Zeit an  
**FUNZ 1 OPZ 9** KB3 zieht 1 Sekunde lang an
- 1SEK** - Das betreffende Relais wird 1 Sekunde lang geschaltet (z.B. zur Aktivierung anderer Zentralen)
- ON/OFF** - Das betreffende Relais wird nur durch nachfolgende, per Funk empfangene Impulse (z.B. Alarme) zu- oder abgeschaltet.
- KANAL** - Es gibt Fernbedienungen mit 1,2,3,4 Tasten, an die die Kanalen A,AB,ABC,ABCD entsprechen. Der Druck auf die Tasten der Fernbedienung entspricht an Kanal A oder C oder C oder D des Radioempfängers.
- FUNZ und OPZ** - Diese Worten entsprechen an Funktion und Option. Ihre Verwendung wird im Handuch AQM erklärt.



Fig.1

Fig.2 RX-DIP

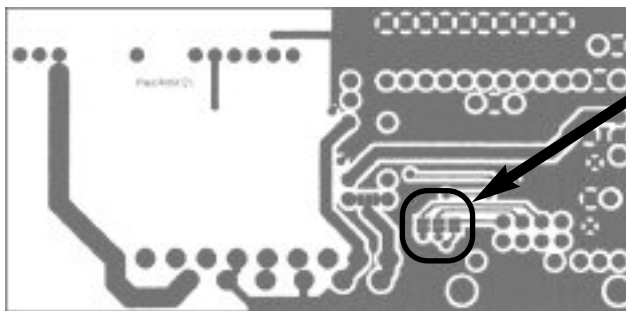
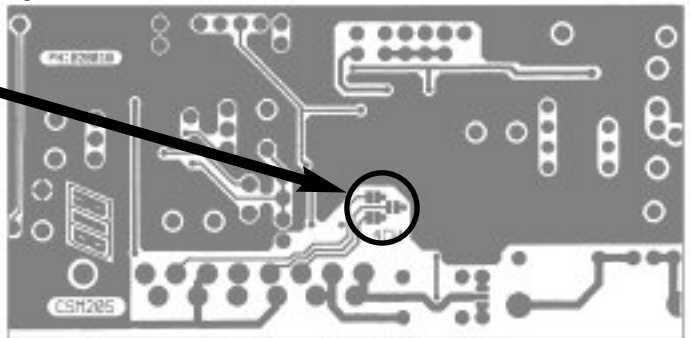

Fig.3 RX-A



4CH

Nun ist die gewünschte Betriebsart wie folgt auszuwählen :

**Einschalten einer (an KB3 angeschlossenen) 40W-Lampe für eine zwischen min. 1 und max. 15 Minuten vorwählbare Zeit: Funktion (FUNZ) 1 und Option (OPZ) 8** für die gewünschte Zeitdauer aktivieren, wie im AQM-Handbuch beschrieben, dann die Verkabelung gemäß Abb. 4 vornehmen.

**Einschalten mehrerer Lampen durch Relais, für eine zwischen min. 1 und max. 15 Minuten vorwählbare Zeit: Funktion (FUNZ) 1 und Option (OPZ) 8** für die gewünschte

Zeitdauer aktivieren, wie im AQM-Handbuch beschrieben, dann die Verkabelung gemäß Abb. 5 vornehmen.

**Einschalten mehrerer Lampen durch Zeitrelais (1 Sekunde): Funktion (FUNZ) 1 und Option (OPZ) 9** für die gewünschte Zeitdauer aktivieren, wie im AQM-Handbuch beschrieben, dann die Verkabelung gemäß Abb. 6 vornehmen.

Hinweis : Die Optionen (OPZ) 8 und 9 können nicht kombiniert werden.

Fig.4

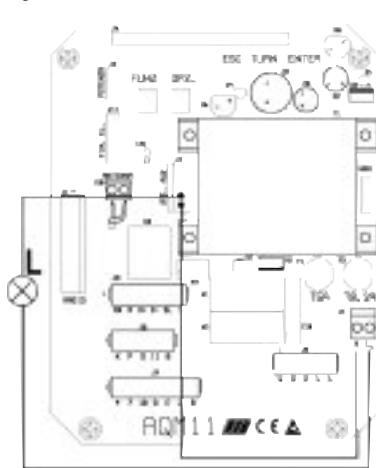

Fig.5

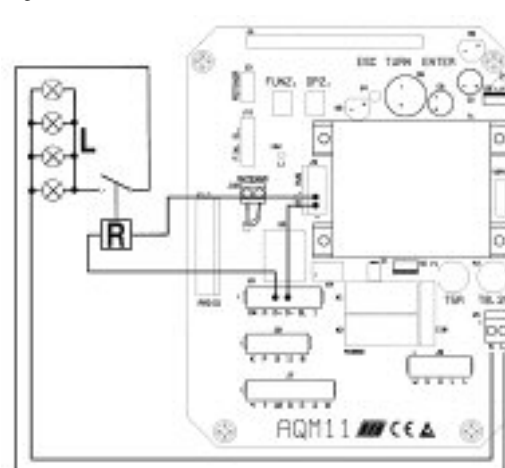
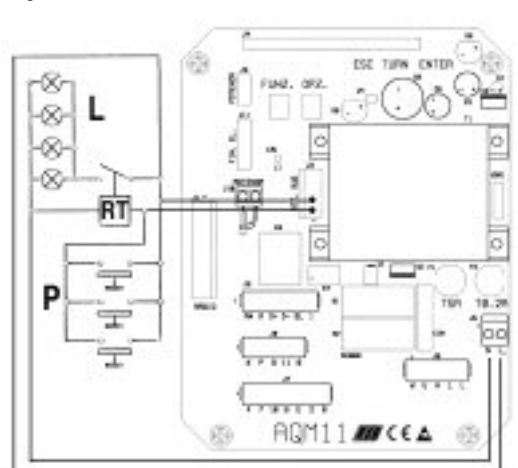

Fig.6



- L = Lampe
- L1N = 230 Vac
- R = Relais

- RT = Zeitrelais
- P = Taster
- D+D = 12 Vdc



25014 CASTENEDOLO (BS)-ITALY  
 Via Matteotti, 162  
 Telefono ++39.030.2135811  
 Telefax ++39.030.21358279  
 e-mail: ribind@ribind.it